

Electronic circuit breaker - PTCB E1 24DC/4A NO



2909906

<https://www.phoenixcontact.com/de/produkte/2909906>

Please be informed that the data shown in this PDF document is generated from our Online Catalog. Please find the complete data in the user documentation. Our General Terms of Use for Downloads are valid.

1-channel, electronic circuit breaker for protecting loads at 24 V DC against overload and short circuit. Easy potential distribution with components from the CLIPLINE complete terminal block system. With fixed nominal current. For installation on DIN rails.



Your advantages

- Simple application setup due to bridging option to CLIPLINE complete terminal block system
- More space in the control cabinet: narrowest protection on just 6 mm width
- Individual setup for suitable protection, exactly according to your requirements

Electronic circuit breaker - PTCB E1 24DC/4A NO



2909906

<https://www.phoenixcontact.com/de/produkte/2909906>

Commercial Data

Item number	2909906
Packing unit	1 pc
Minimum order quantity	1 pc
Note	Made to Order (non-returnable)
Sales Key	L1 - Schutzschalter
Product Key	CLA135
Catalog Page	Page 379 (C-4-2019)
GTIN	4055626408736
Weight per Piece (including packing)	44,2 g
Weight per Piece (excluding packing)	27,58 g
Customs tariff number	85363010
Country of origin	DE

Electronic circuit breaker - PTCB E1 24DC/4A NO



2909906

<https://www.phoenixcontact.com/de/produkte/2909906>

Technical Data

Notes

General

Note	EN 50121-3-2: Railway applications - Electromagnetic compatibility - Part 3-2: Rolling stock – Apparatus
	Connection for signal line tested in accordance with EN 61000-4-4 with 1 kV; if necessary, customer must provide appropriate protective measures
	Repeated hard short circuits can reduce the melting integral of the integrated backup fuse.

Product properties

Type	DIN rail module, one-piece
Product type	Device circuit breakers
Number of positions	1
No. of channels	1

Insulation characteristics

Protection class	III
Pollution degree	2

Electrical properties

No. of channels	1
Operating voltage	18 V DC ... 30 V DC
Rated voltage	24 V DC
Rated current I_N	24 A DC (Total current input)
	4 A DC (Rated current output)
Rated current (pre-adjusted)	4 A
Rated surge voltage	0.5 kV
Tripping method	E (electronic)
Feedback resistance	max. 35 V DC
Required backup fuse	Only required if I_{max} of the power supply > the short-circuit switching capacity. Integrated failsafe element.
Short-circuit switching capacity	300 A
Dielectric strength	max. 35 V DC (Load circuit)
Fuse	electronic
Efficiency	> 99 %
Closed circuit current I_0	typ. 12 mA
Power dissipation	typ. 0.3 W (No-load operation)
	< 1.3 W (Nominal operation)
Module initialization time	1 s
Waiting time after switch off of a channel	5 s (at overload / short circuit)
Measuring tolerance I	± 15 %
	21 A (Total current at 60°C)

Electronic circuit breaker - PTCB E1 24DC/4A NO



2909906

<https://www.phoenixcontact.com/de/produkte/2909906>

Temperature derating	24 A (Total current at 50°C)
	4 A (Channel current at 60°C)
	4 A (Channel current at 50°C)
MTBF (IEC 61709, SN 29500)	28571428 h (at 25 °C with 21 % load)
	14084507 h (at 40°C with 34.25% load)
	2053388 h (at 60°C with 100% load)
Voltage drop	0.12 V (at 4 A)
Fail-safe element	4 A DC
Shutdown time	≤ 10 ms (for short circuit > 2.0 x I _N)
	1 s (1.2 ... 2.0 x I _N)
Undervoltage switch-off	≤ 17.8 V DC (active)
	≥ 18.8 V DC (inactive)
Overvoltage switch-off	≥ 30.5 V DC (active)
	≤ 29.5 V DC (inactive)
Max. capacitive load	20000 µF (Depending on the available short-circuit current)

Indicator/remote signaling

Connection name	Remote indication circuit
Switching function	N/O contact
Operating voltage	0 V DC ... 30 V DC
Operating current	100 mA DC

Connection data

Main circuit IN+

Connection method	Push-in connection
Stripping length	8 mm
Conductor cross section flexible	0.2 mm ² ... 2.5 mm ²
Conductor cross section solid	0.2 mm ² ... 4 mm ²
Conductor cross section AWG	24 ... 12
Conductor cross section, flexible, with ferrule, with plastic sleeve	0.2 mm ² ... 2.5 mm ²
Conductor cross section flexible, with ferrule without plastic sleeve	0.2 mm ² ... 2.5 mm ²

Main circuit IN+

Connection method	Push-in connection
Stripping length	8 mm
Conductor cross section flexible	0.2 mm ² ... 2.5 mm ²
Conductor cross section solid	0.2 mm ² ... 4 mm ²
Conductor cross section AWG	24 ... 12
Conductor cross section, flexible, with ferrule, with plastic sleeve	0.2 mm ² ... 2.5 mm ²
Conductor cross section flexible, with ferrule without plastic sleeve	0.2 mm ² ... 2.5 mm ²

Main circuit IN+

Connection method	Push-in connection
-------------------	--------------------

Electronic circuit breaker - PTCB E1 24DC/4A NO



2909906

<https://www.phoenixcontact.com/de/produkte/2909906>

Stripping length	8 mm
Conductor cross section flexible	0.2 mm ² ... 2.5 mm ²
Conductor cross section solid	0.2 mm ² ... 4 mm ²
Conductor cross section AWG	24 ... 12
Conductor cross section, flexible, with ferrule, with plastic sleeve	0.2 mm ² ... 2.5 mm ²
Conductor cross section flexible, with ferrule without plastic sleeve	0.2 mm ² ... 2.5 mm ²

LED signaling

Channel LED off	off (Channel switched off)
Channel LED yellow	lit (Channel switched on, channel load > 80%) flashing (Programming mode active)
Channel LED green	lit (Channel switched on)
Channel LED red	lit (Channel switched off, over- or undervoltage active) ON temporarily (Channel switched off, 5 s cool-down phase, overload or short-circuit release) flashing (Channel switched off, ready to be switched back on, overload or short-circuit release) flashing quickly (Channel switched off, external voltage at the output, possible installation error)

Dimensions

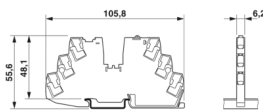
Dimensional drawing	
Width	6.2 mm
Height	105.8 mm
Depth	55.6 mm (incl. DIN rail 7.5 mm)

Material specifications

Color	traffic grey A RAL 7042
Material	PBT (Housing) PBT (Pusher)
Flammability rating according to UL 94	V-0

Environmental and real-life conditions

Ambient conditions

Degree of protection	IP20
Ambient temperature (operation)	-30 °C ... 60 °C
Ambient temperature (storage/transport)	-40 °C ... 70 °C
Altitude	≤ 3000 m up to 52 °C (amsl (above mean sea level)) ≤ 4000 m up to 46 °C (amsl (above mean sea level))
Humidity test	96 h, 95 % RH, 40 °C

Electronic circuit breaker - PTCB E1 24DC/4A NO



2909906

<https://www.phoenixcontact.com/de/produkte/2909906>

Shock (operation)	30g (IEC 60068-2-27, Test Ea)
Vibration (operation)	10 Hz ... 59.6 Hz (Amplitude ± 0.35 mm; in accordance with IEC 60068-2-6, Test Fc)
	59.6 Hz ... 150 Hz (Acceleration 5g; in accordance with IEC 60068-2-6, Test Fc)
	5 Hz ... 100 Hz (Resonance search 4g; resonance frequency 4g; 90 min in accordance with DNV GL Class B)

Approval data

UL approval

Identification	UL/C-UL Listed UL 508
	UL Recognized UL 2367
	UL/C-UL Listed ANSI/UL 121201 Class I, Division 2, Groups A, B, C, D; T4 (Hazardous Location)

UL approval

Identification	DNV GL
----------------	--------

DNV GL data

Temperature	D
Humidity	B
Vibration	B
EMC	B
Enclosure	A

Standards and regulations

Standards/specifications	EN 61000-6-2
Standards/specifications	EN 61000-6-3
Standards/specifications	EN 60068-2-78
Standards/specifications	EN 50178
Standards/specifications	EN 60068-2-6
Standards/specifications	EN 60068-2-27
Standards/specifications	EN 60068-2-30
Standards/specifications	EN 61373
Standards/specifications	EN 45545-2

Mounting

Mounting type	DIN rail: 35 mm
---------------	-----------------

Electronic circuit breaker - PTCB E1 24DC/4A NO



2909906

<https://www.phoenixcontact.com/de/produkte/2909906>

Drawings

Block diagram

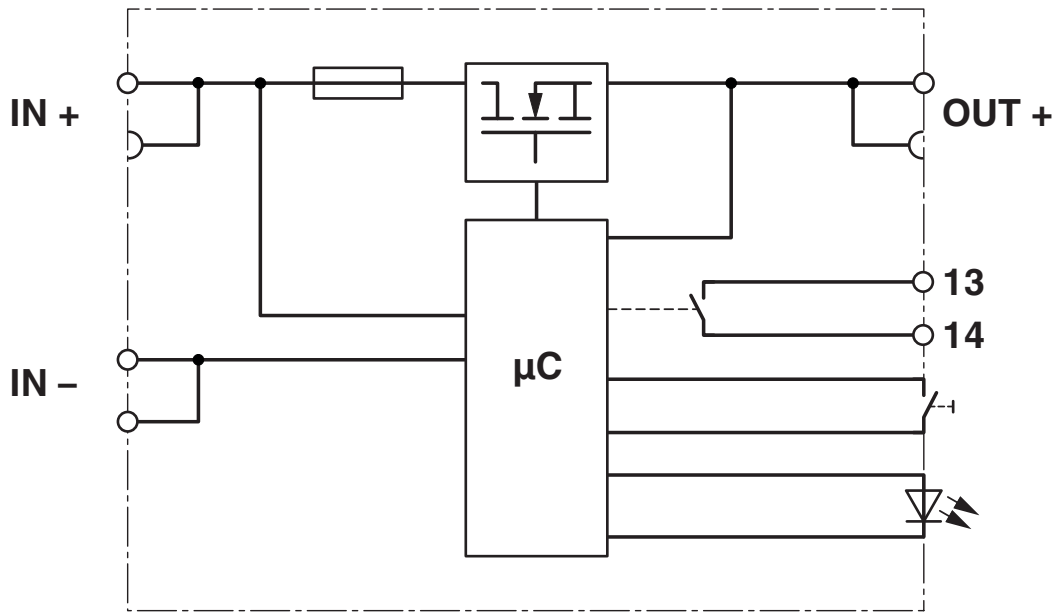

Dimensional drawing

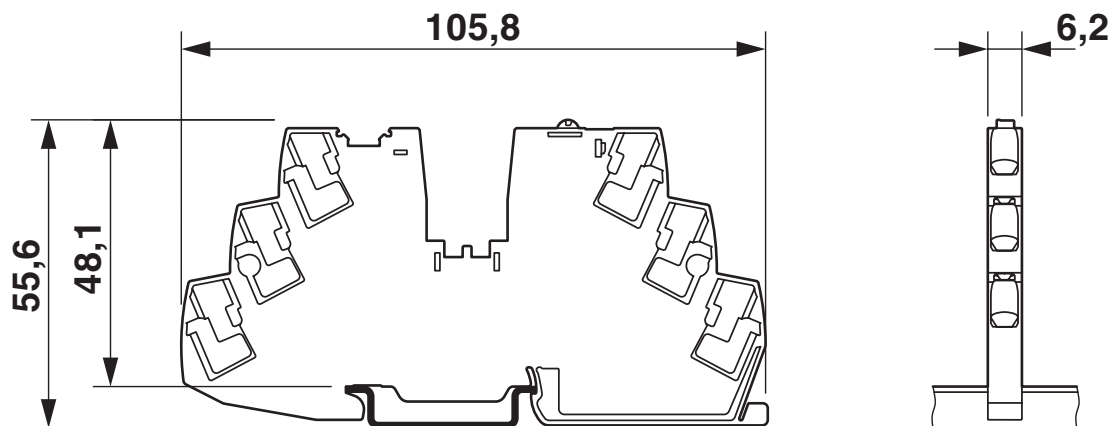

Electronic circuit breaker - PTCB E1 24DC/4A NO



2909906

<https://www.phoenixcontact.com/de/produkte/2909906>

Diagram

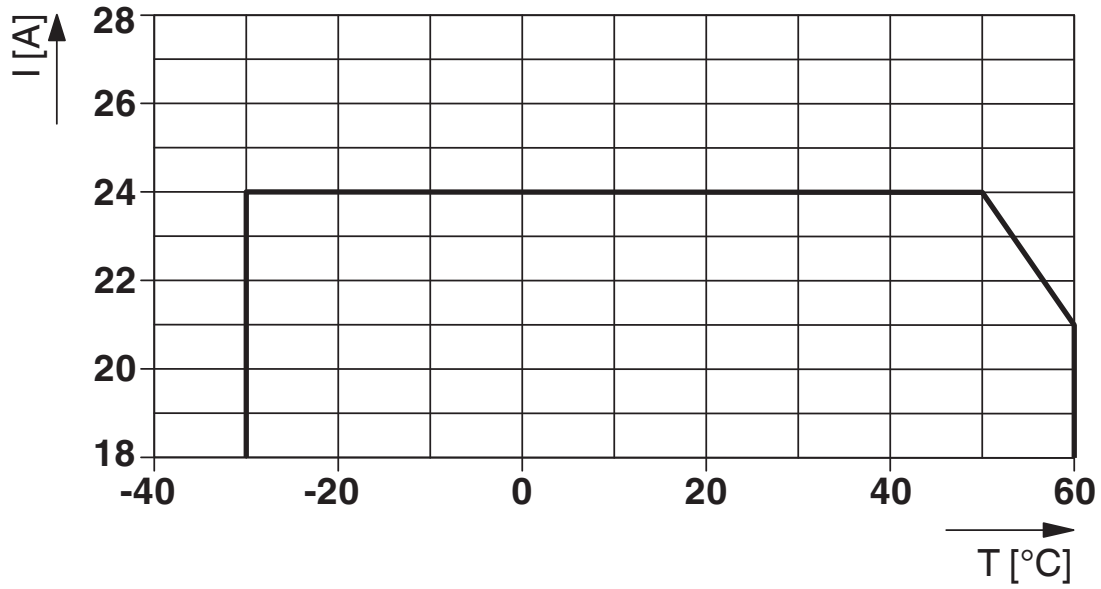

Total current input

Electronic circuit breaker - PTCB E1 24DC/4A NO



2909906

<https://www.phoenixcontact.com/de/produkte/2909906>

Product drawing



Application drawing

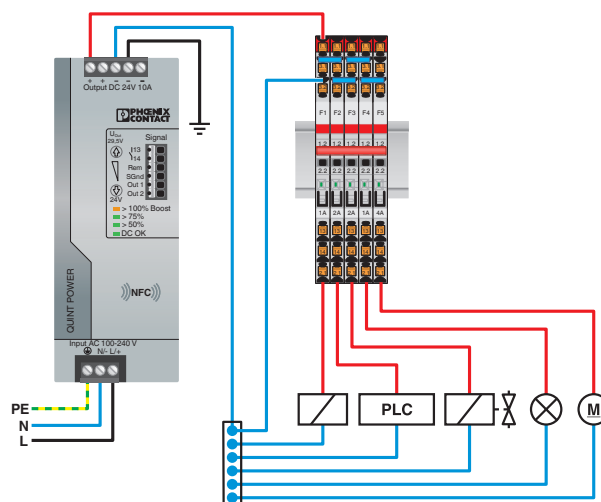

Electronic circuit breaker - PTCB E1 24DC/4A NO

2909906

<https://www.phoenixcontact.com/de/produkte/2909906>

Application drawing

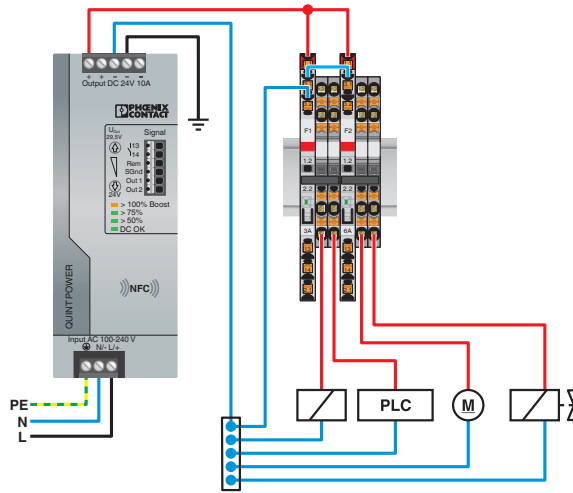

Diagram

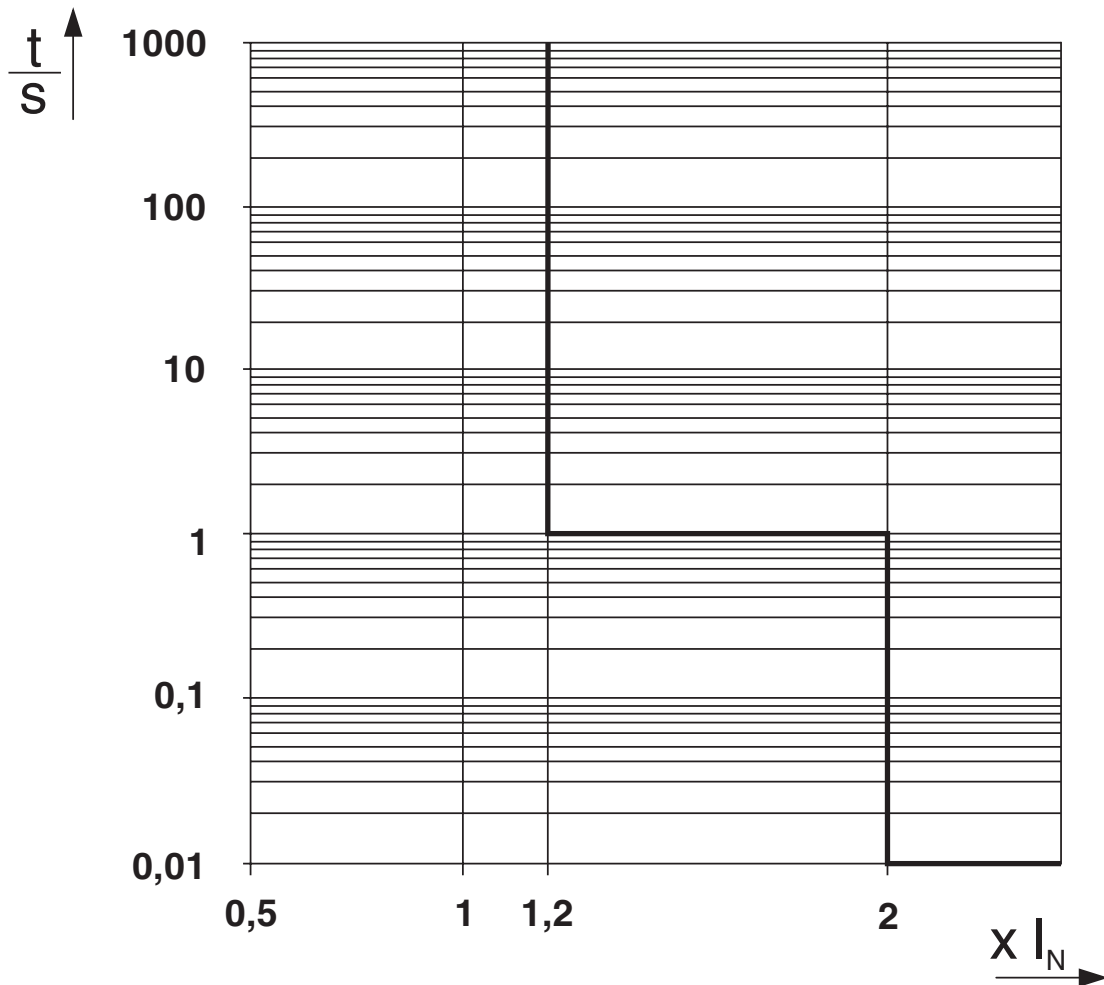

Trigger characteristic in the DC range

Electronic circuit breaker - PTCB E1 24DC/4A NO



2909906

<https://www.phoenixcontact.com/de/produkte/2909906>

Approvals



UL Recognized

Approval ID: FILE E 317172



DNV GL

Approval ID: TAE00003UT

Nominal Voltage U_N

Nominal Current I_N

Cross Section AWG

Cross Section mm^2

-

-



UL Listed

Approval ID: FILE E 123528



cUL Listed

Approval ID: FILE E 123528



UL Recognized

Approval ID: FILE E 324415



cUL Listed

Approval ID: FILE E 483407



UL Listed

Approval ID: FILE E 483407

cULus Listed

cULus Listed

Electronic circuit breaker - PTCB E1 24DC/4A NO



2909906

<https://www.phoenixcontact.com/de/produkte/2909906>

Classifications

ECLASS

ECLASS-9.0	27141116
ECLASS-10.0.1	27140401
ECLASS-11.0	27140401

ETIM

ETIM 8.0	EC003538
----------	----------

UNSPSC

UNSPSC 21.0	39121400
-------------	----------

Electronic circuit breaker - PTCB E1 24DC/4A NO



2909906

<https://www.phoenixcontact.com/de/produkte/2909906>

Environmental Product Compliance

REACH SVHC	Lead 7439-92-1
China RoHS	Environmentally Friendly Use Period = 50 years
	For information on hazardous substances, refer to the manufacturer's declaration available under "Downloads"

Electronic circuit breaker - PTCB E1 24DC/4A NO

2909906

<https://www.phoenixcontact.com/de/produkte/2909906>

Accessories

 Note: Applying some accessories below might limit this product.

Plug-in bridge

Plug-in bridge - FBS 2-6 - 3030336

<https://www.phoenixcontact.com/de/produkte/3030336>



Plug-in bridge, pitch: 6.2 mm, color: red

 Max. current carrying capacity: 32 A

Plug-in bridge

Plug-in bridge - FBS 3-6 - 3030242

<https://www.phoenixcontact.com/de/produkte/3030242>



Plug-in bridge, pitch: 6.2 mm, color: red

 Max. current carrying capacity: 32 A

Electronic circuit breaker - PTCB E1 24DC/4A NO

2909906

<https://www.phoenixcontact.com/de/produkte/2909906>

Plug-in bridge

Plug-in bridge - FBS 4-6 - 3030255

<https://www.phoenixcontact.com/de/produkte/3030255>



Plug-in bridge, pitch: 6.2 mm, color: red

 Max. current carrying capacity: 32 A

Plug-in bridge

Plug-in bridge - FBS 5-6 - 3030349

<https://www.phoenixcontact.com/de/produkte/3030349>



Plug-in bridge, pitch: 6.2 mm, color: red

 Max. current carrying capacity: 32 A

Electronic circuit breaker - PTCB E1 24DC/4A NO

2909906

<https://www.phoenixcontact.com/de/produkte/2909906>

Plug-in bridge

Plug-in bridge - FBS 10-6 - 3030271

<https://www.phoenixcontact.com/de/produkte/3030271>

Plug-in bridge, pitch: 6.2 mm, color: red



 Max. current carrying capacity: 32 A

Plug-in bridge

Plug-in bridge - FBS 20-6 - 3030365

<https://www.phoenixcontact.com/de/produkte/3030365>

Plug-in bridge, pitch: 6.2 mm, color: red



 Max. current carrying capacity: 32 A

Electronic circuit breaker - PTCB E1 24DC/4A NO

2909906

<https://www.phoenixcontact.com/de/produkte/2909906>



Plug-in bridge

Plug-in bridge - FBS 50-6 - 3032224

<https://www.phoenixcontact.com/de/produkte/3032224>



Plug-in bridge, pitch: 6.2 mm, color: red

 Max. current carrying capacity: 32 A

Plug-in bridge

Plug-in bridge - FBS 2-6 BU - 3036932

<https://www.phoenixcontact.com/de/produkte/3036932>



Plug-in bridge, pitch: 6.2 mm, color: blue

 Max. current carrying capacity: 32 A

Electronic circuit breaker - PTCB E1 24DC/4A NO

2909906

<https://www.phoenixcontact.com/de/produkte/2909906>

Plug-in bridge

Plug-in bridge - FBS 3-6 BU - 3036945

<https://www.phoenixcontact.com/de/produkte/3036945>



Plug-in bridge, pitch: 6.2 mm, color: blue

 Max. current carrying capacity: 32 A

Plug-in bridge

Plug-in bridge - FBS 4-6 BU - 3036958

<https://www.phoenixcontact.com/de/produkte/3036958>



Plug-in bridge, pitch: 6.2 mm, color: blue

 Max. current carrying capacity: 32 A

Electronic circuit breaker - PTCB E1 24DC/4A NO

2909906

<https://www.phoenixcontact.com/de/produkte/2909906>

Plug-in bridge

Plug-in bridge - FBS 5-6 BU - 3036961

<https://www.phoenixcontact.com/de/produkte/3036961>



Plug-in bridge, pitch: 6.2 mm, color: blue

 Max. current carrying capacity: 32 A

Plug-in bridge

Plug-in bridge - FBS 10-6 BU - 3032198

<https://www.phoenixcontact.com/de/produkte/3032198>



Plug-in bridge, pitch: 6.2 mm, color: blue

 Max. current carrying capacity: 32 A

Electronic circuit breaker - PTCB E1 24DC/4A NO

2909906

<https://www.phoenixcontact.com/de/produkte/2909906>

Plug-in bridge

Plug-in bridge - FBS 20-6 BU - 3032208

<https://www.phoenixcontact.com/de/produkte/3032208>

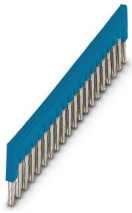

Plug-in bridge, pitch: 6.2 mm, color: blue

 Max. current carrying capacity: 32 A

Plug-in bridge

Plug-in bridge - FBS 50-6 BU - 3032211

<https://www.phoenixcontact.com/de/produkte/3032211>

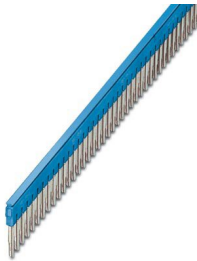

Plug-in bridge, pitch: 6.2 mm, color: blue

 Max. current carrying capacity: 32 A

Electronic circuit breaker - PTCB E1 24DC/4A NO

2909906

<https://www.phoenixcontact.com/de/produkte/2909906>

Plug-in bridge

Plug-in bridge - FBS 2-6 GY - 3032237

<https://www.phoenixcontact.com/de/produkte/3032237>



Plug-in bridge, pitch: 6.2 mm, color: gray

 Max. current carrying capacity: 32 A

Plug-in bridge

Plug-in bridge - FBS 3-6 GY - 3032240

<https://www.phoenixcontact.com/de/produkte/3032240>



Plug-in bridge, pitch: 6.2 mm, color: gray

 Max. current carrying capacity: 32 A

Electronic circuit breaker - PTCB E1 24DC/4A NO

2909906

<https://www.phoenixcontact.com/de/produkte/2909906>

Plug-in bridge

Plug-in bridge - FBS 4-6 GY - 3032279

<https://www.phoenixcontact.com/de/produkte/3032279>



Plug-in bridge, pitch: 6.2 mm, color: gray

 Max. current carrying capacity: 32 A

Plug-in bridge

Plug-in bridge - FBS 5-6 GY - 3032266

<https://www.phoenixcontact.com/de/produkte/3032266>



Plug-in bridge, pitch: 6.2 mm, color: gray

 Max. current carrying capacity: 32 A

Electronic circuit breaker - PTCB E1 24DC/4A NO

2909906

<https://www.phoenixcontact.com/de/produkte/2909906>

Plug-in bridge

Plug-in bridge - FBS 2-5 - 3030161

<https://www.phoenixcontact.com/de/produkte/3030161>



Plug-in bridge, pitch: 5.2 mm, color: red

 Max. current carrying capacity: 24 A

Plug-in bridge

Plug-in bridge - FBS 3-5 - 3030174

<https://www.phoenixcontact.com/de/produkte/3030174>



Plug-in bridge, pitch: 5.2 mm, color: red

 Max. current carrying capacity: 24 A

Electronic circuit breaker - PTCB E1 24DC/4A NO

2909906

<https://www.phoenixcontact.com/de/produkte/2909906>

Plug-in bridge

Plug-in bridge - FBS 4-5 - 3030187

<https://www.phoenixcontact.com/de/produkte/3030187>



Plug-in bridge, pitch: 5.2 mm, color: red

 Max. current carrying capacity: 24 A

Plug-in bridge

Plug-in bridge - FBS 5-5 - 3030190

<https://www.phoenixcontact.com/de/produkte/3030190>



Plug-in bridge, pitch: 5.2 mm, color: red

 Max. current carrying capacity: 24 A

Electronic circuit breaker - PTCB E1 24DC/4A NO

2909906

<https://www.phoenixcontact.com/de/produkte/2909906>

Plug-in bridge

Plug-in bridge - FBS 10-5 - 3030213

<https://www.phoenixcontact.com/de/produkte/3030213>



Plug-in bridge, pitch: 5.2 mm, color: red

 Max. current carrying capacity: 24 A

Plug-in bridge

Plug-in bridge - FBS 20-5 - 3030226

<https://www.phoenixcontact.com/de/produkte/3030226>



Plug-in bridge, pitch: 5.2 mm, color: red

 Max. current carrying capacity: 24 A

Electronic circuit breaker - PTCB E1 24DC/4A NO

2909906

<https://www.phoenixcontact.com/de/produkte/2909906>

Plug-in bridge

Plug-in bridge - FBS 50-5 - 3038930

<https://www.phoenixcontact.com/de/produkte/3038930>



Plug-in bridge, pitch: 5.2 mm, color: red

 Max. current carrying capacity: 24 A

Plug-in bridge

Plug-in bridge - FBS 2-5 BU - 3036877

<https://www.phoenixcontact.com/de/produkte/3036877>



Plug-in bridge, pitch: 5.2 mm, color: blue

 Max. current carrying capacity: 24 A

Electronic circuit breaker - PTCB E1 24DC/4A NO

2909906

<https://www.phoenixcontact.com/de/produkte/2909906>

Plug-in bridge

Plug-in bridge - FBS 3-5 BU - 3036880

<https://www.phoenixcontact.com/de/produkte/3036880>



Plug-in bridge, pitch: 5.2 mm, color: blue

 Max. current carrying capacity: 24 A

Plug-in bridge

Plug-in bridge - FBS 4-5 BU - 3036893

<https://www.phoenixcontact.com/de/produkte/3036893>



Plug-in bridge, pitch: 5.2 mm, color: blue

 Max. current carrying capacity: 24 A

Electronic circuit breaker - PTCB E1 24DC/4A NO

2909906

<https://www.phoenixcontact.com/de/produkte/2909906>

Plug-in bridge

Plug-in bridge - FBS 5-5 BU - 3036903

<https://www.phoenixcontact.com/de/produkte/3036903>



Plug-in bridge, pitch: 5.2 mm, color: blue

 Max. current carrying capacity: 24 A

Plug-in bridge

Plug-in bridge - FBS 10-5 BU - 3036916

<https://www.phoenixcontact.com/de/produkte/3036916>



Plug-in bridge, pitch: 5.2 mm, color: blue

 Max. current carrying capacity: 24 A

Electronic circuit breaker - PTCB E1 24DC/4A NO

2909906

<https://www.phoenixcontact.com/de/produkte/2909906>

Plug-in bridge

Plug-in bridge - FBS 20-5 BU - 3036929

<https://www.phoenixcontact.com/de/produkte/3036929>



Plug-in bridge, pitch: 5.2 mm, color: blue

 Max. current carrying capacity: 24 A

Plug-in bridge

Plug-in bridge - FBS 50-5 BU - 3032114

<https://www.phoenixcontact.com/de/produkte/3032114>



Plug-in bridge, Version with single- or double-sided cutting edge. Please keep in mind the possible impact on touch protection as well as air clearances and creepage distances., pitch: 5.2 mm, color: blue

 Max. current carrying capacity: 24 A

Electronic circuit breaker - PTCB E1 24DC/4A NO

2909906

<https://www.phoenixcontact.com/de/produkte/2909906>

Plug-in bridge

Plug-in bridge - FBS 2-5 GY - 3038969

<https://www.phoenixcontact.com/de/produkte/3038969>



Plug-in bridge, pitch: 5.2 mm, color: gray

 Max. current carrying capacity: 24 A

Plug-in bridge

Plug-in bridge - FBS 3-5 GY - 3038972

<https://www.phoenixcontact.com/de/produkte/3038972>



Plug-in bridge, pitch: 5.2 mm, color: gray

 Max. current carrying capacity: 24 A

Electronic circuit breaker - PTCB E1 24DC/4A NO

2909906

<https://www.phoenixcontact.com/de/produkte/2909906>

Plug-in bridge

Plug-in bridge - FBS 4-5 GY - 3038985

<https://www.phoenixcontact.com/de/produkte/3038985>



Plug-in bridge, pitch: 5.2 mm, color: gray

 Max. current carrying capacity: 24 A

Plug-in bridge

Plug-in bridge - FBS 5-5 GY - 3038998

<https://www.phoenixcontact.com/de/produkte/3038998>



Plug-in bridge, pitch: 5.2 mm, color: gray

 Max. current carrying capacity: 24 A

Electronic circuit breaker - PTCB E1 24DC/4A NO

2909906

<https://www.phoenixcontact.com/de/produkte/2909906>

Reducing bridge

Reducing bridge - RB ST 10-(2,5/4) - 3030873

<https://www.phoenixcontact.com/de/produkte/3030873>



Reducing bridge, pitch: 10 mm, color: red

Feed-through terminal block

Feed-through terminal block - PT 4 - 3211757

<https://www.phoenixcontact.com/de/produkte/3211757>

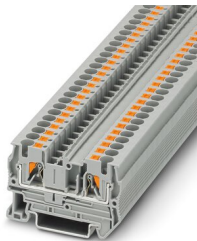

Feed-through terminal block, nom. voltage: 800 V, nominal current: 32 A, connection method: Push-in connection, 1 level, Rated cross section: 4 mm², cross section: 0.2 mm² - 6 mm², mounting type: NS 35/7,5, NS 35/15, color: gray

Electronic circuit breaker - PTCB E1 24DC/4A NO

2909906

<https://www.phoenixcontact.com/de/produkte/2909906>

Feed-through terminal block

Feed-through terminal block - PT 4-TWIN - 3211771

<https://www.phoenixcontact.com/de/produkte/3211771>



Feed-through terminal block, nom. voltage: 800 V, nominal current: 32 A, connection method: Push-in connection, 1 level, Rated cross section: 4 mm², cross section: 0.2 mm² - 6 mm², mounting type: NS 35/7,5, NS 35/15, color: gray

Feed-through terminal block

Feed-through terminal block - PT 4-QUATTRO - 3211797

<https://www.phoenixcontact.com/de/produkte/3211797>



Feed-through terminal block, nom. voltage: 800 V, nominal current: 32 A, connection method: Push-in connection, 1 level, Rated cross section: 4 mm², cross section: 0.2 mm² - 6 mm², mounting type: NS 35/7,5, NS 35/15, color: gray

Electronic circuit breaker - PTCB E1 24DC/4A NO

2909906

<https://www.phoenixcontact.com/de/produkte/2909906>

Feed-through terminal block

Feed-through terminal block - ST 4 - 3031364

<https://www.phoenixcontact.com/de/produkte/3031364>

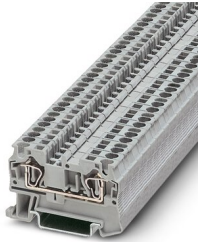

Feed-through terminal block, nom. voltage: 800 V, nominal current: 32 A, connection method: Spring-cage connection, 1 level, Rated cross section: 4 mm², cross section: 0.08 mm² - 6 mm², mounting type: NS 35/7,5, NS 35/15, color: gray

Feed-through terminal block

Feed-through terminal block - ST 4-TWIN - 3031393

<https://www.phoenixcontact.com/de/produkte/3031393>

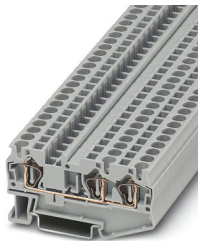

Feed-through terminal block, nom. voltage: 800 V, nominal current: 32 A, connection method: Spring-cage connection, 1 level, Rated cross section: 4 mm², cross section: 0.08 mm² - 6 mm², mounting type: NS 35/7,5, NS 35/15, color: gray

Electronic circuit breaker - PTCB E1 24DC/4A NO

2909906

<https://www.phoenixcontact.com/de/produkte/2909906>

Feed-through terminal block

Feed-through terminal block - ST 4-QUATTRO - 3031445

<https://www.phoenixcontact.com/de/produkte/3031445>



Feed-through terminal block, nom. voltage: 800 V, nominal current: 32 A, connection method: Spring-cage connection, 1 level, Rated cross section: 4 mm², cross section: 0.08 mm² - 6 mm², mounting type: NS 35/7,5, NS 35/15, color: gray

Feed-through terminal block

Feed-through terminal block - QTC 2,5 - 3206416

<https://www.phoenixcontact.com/de/produkte/3206416>

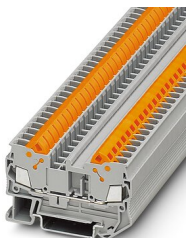

Feed-through terminal block, nom. voltage: 800 V, nominal current: 24 A, connection method: Quick connection, 1 level, Rated cross section: 2.5 mm², cross section: 0.5 mm² - 2.5 mm², mounting type: NS 35/7,5, NS 35/15, color: gray

Electronic circuit breaker - PTCB E1 24DC/4A NO

2909906

<https://www.phoenixcontact.com/de/produkte/2909906>

Feed-through terminal block

Feed-through terminal block - QTC 2,5-TWIN - 3206445

<https://www.phoenixcontact.com/de/produkte/3206445>

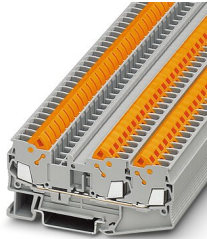

Feed-through terminal block, nom. voltage: 800 V, nominal current: 24 A, connection method: Quick connection, 1 level, Rated cross section: 2.5 mm², cross section: 0.5 mm² - 2.5 mm², mounting type: NS 35/7,5, NS 35/7,5, color: gray

Feed-through terminal block

Feed-through terminal block - QTC 2,5-QUATTRO - 3206446

<https://www.phoenixcontact.com/de/produkte/3206446>

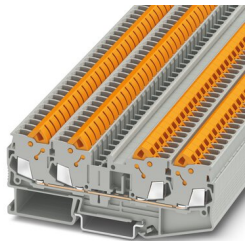

Feed-through terminal block, nom. voltage: 800 V, nominal current: 24 A, connection method: Quick connection, 1 level, Rated cross section: 2.5 mm², cross section: 0.5 mm² - 2.5 mm², mounting type: NS 35/7,5, NS 35/7,5, color: gray

Electronic circuit breaker - PTCB E1 24DC/4A NO

2909906

<https://www.phoenixcontact.com/de/produkte/2909906>

Feed-through terminal block

Feed-through terminal block - PT 2,5 - 3209510

<https://www.phoenixcontact.com/de/produkte/3209510>

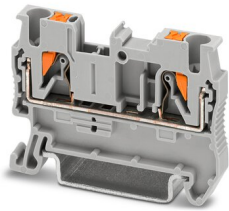

Feed-through terminal block, nom. voltage: 800 V, nominal current: 24 A, connection method: Push-in connection, 1 level, Rated cross section: 2.5 mm², cross section: 0.14 mm² - 4 mm², mounting type: NS 35/7,5, NS 35/15, color: gray

Feed-through terminal block

Feed-through terminal block - PT 2,5-TWIN - 3209549

<https://www.phoenixcontact.com/de/produkte/3209549>

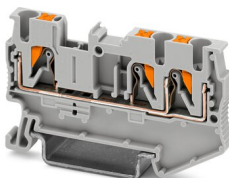

Feed-through terminal block, nom. voltage: 800 V, nominal current: 24 A, connection method: Push-in connection, 1 level, Rated cross section: 2.5 mm², cross section: 0.14 mm² - 4 mm², mounting type: NS 35/7,5, NS 35/15, color: gray

Electronic circuit breaker - PTCB E1 24DC/4A NO

2909906

<https://www.phoenixcontact.com/de/produkte/2909906>

Feed-through terminal block

Feed-through terminal block - PT 2,5-QUATTRO - 3209578

<https://www.phoenixcontact.com/de/produkte/3209578>

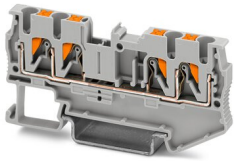

Feed-through terminal block, nom. voltage: 800 V, nominal current: 24 A, connection method: Push-in connection, 1 level, Rated cross section: 2.5 mm², cross section: 0.14 mm² - 4 mm², mounting type: NS 35/7,5, NS 35/15, color: gray

Feed-through terminal block

Feed-through terminal block - ST 2,5 - 3031212

<https://www.phoenixcontact.com/de/produkte/3031212>

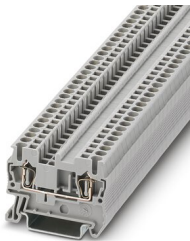

Feed-through terminal block, nom. voltage: 800 V, nominal current: 24 A, connection method: Spring-cage connection, 1 level, Rated cross section: 2.5 mm², cross section: 0.08 mm² - 4 mm², mounting type: NS 35/7,5, NS 35/15, color: gray

Electronic circuit breaker - PTCB E1 24DC/4A NO

2909906

<https://www.phoenixcontact.com/de/produkte/2909906>

Feed-through terminal block

Feed-through terminal block - ST 2,5-TWIN - 3031241

<https://www.phoenixcontact.com/de/produkte/3031241>

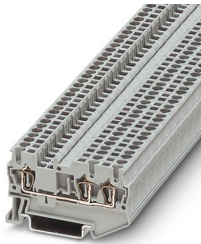

Feed-through terminal block, nom. voltage: 800 V, nominal current: 24 A, connection method: Spring-cage connection, Rated cross section: 2.5 mm², cross section: 0.08 mm² - 4 mm², mounting type: NS 35/7,5, NS 35/15, color: gray

Feed-through terminal block

Feed-through terminal block - ST 2,5-QUATTRO - 3031306

<https://www.phoenixcontact.com/de/produkte/3031306>

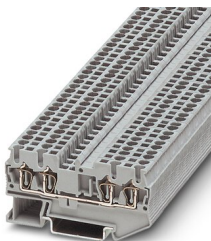

Feed-through terminal block, nom. voltage: 800 V, nominal current: 24 A, connection method: Spring-cage connection, Rated cross section: 2.5 mm², cross section: 0.08 mm² - 4 mm², mounting type: NS 35/7,5, NS 35/15, color: gray

Electronic circuit breaker - PTCB E1 24DC/4A NO

2909906

<https://www.phoenixcontact.com/de/produkte/2909906>

Fast connection terminal block

Fast connection terminal block - QTC 1,5 - 3205019

<https://www.phoenixcontact.com/de/produkte/3205019>

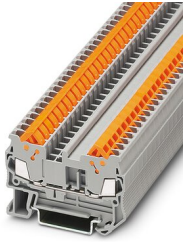

Fast connection terminal block, nom. voltage: 800 V, nominal current: 17.5 A, connection method: Quick connection, 1 level, Rated cross section: 1.5 mm², cross section: 0.25 mm² - 1.5 mm², mounting type: NS 35/7,5, NS 35/15, color: gray

Feed-through terminal block

Feed-through terminal block - QTC 1,5-TWIN - 3205048

<https://www.phoenixcontact.com/de/produkte/3205048>

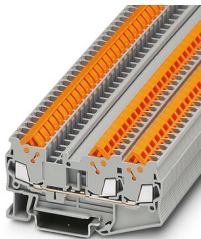

Feed-through terminal block, nom. voltage: 800 V, nominal current: 17.5 A, connection method: Quick connection, 1 level, Rated cross section: 1.5 mm², cross section: 0.25 mm² - 1.5 mm², mounting type: NS 35/7,5, NS 35/7,5, color: gray

Electronic circuit breaker - PTCB E1 24DC/4A NO

2909906

<https://www.phoenixcontact.com/de/produkte/2909906>

Feed-through terminal block

Feed-through terminal block - QTC 1,5-QUATTRO - 3205077

<https://www.phoenixcontact.com/de/produkte/3205077>

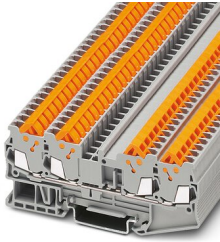

Feed-through terminal block, nom. voltage: 800 V, nominal current: 17.5 A, connection method: Quick connection, 1 level, Rated cross section: 1.5 mm², cross section: 0.25 mm² - 1.5 mm², mounting type: NS 35/7,5, NS 35/7,5, color: gray

Feed-through terminal block

Feed-through terminal block - PT 10 - 3212120

<https://www.phoenixcontact.com/de/produkte/3212120>

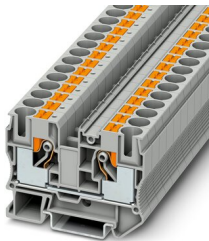

Feed-through terminal block, nom. voltage: 1000 V, nominal current: 57 A, connection method: Push-in connection, Rated cross section: 10 mm², cross section: 0.5 mm² - 16 mm², mounting type: NS 35/7,5, NS 35/15, color: gray

Electronic circuit breaker - PTCB E1 24DC/4A NO

2909906

<https://www.phoenixcontact.com/de/produkte/2909906>

Feed-through terminal block

Feed-through terminal block - ST 10 - 3036110

<https://www.phoenixcontact.com/de/produkte/3036110>



Feed-through terminal block, nom. voltage: 1000 V, nominal current: 57 A, connection method: Spring-cage connection, 1 level, Rated cross section: 10 mm², cross section: 0.2 mm² - 16 mm², mounting type: NS 35/7,5, NS 35/15, color: gray

Zack marker strip

Zack marker strip - ZB 6:UNBEDRUCKT - 1051003

<https://www.phoenixcontact.com/de/produkte/1051003>



Zack marker strip, Strip, white, unlabeled, can be labeled with: PLOTMARK, CMS-P1-PLOTTER, mounting type: snapped, for terminal block width: 6.2 mm, lettering field size: 6.15 x 10.5 mm, Number of individual labels: 10

Electronic circuit breaker - PTCB E1 24DC/4A NO

2909906

<https://www.phoenixcontact.com/de/produkte/2909906>

Zack Marker strip, flat

Zack Marker strip, flat - ZBF 6:UNBEDRUCKT - 0808710

<https://www.phoenixcontact.com/de/produkte/0808710>



Zack Marker strip, flat, Strip, white, unlabeled, can be labeled with: PLOTMARK, CMS-P1-PLOTTER, mounting type: snapped, for terminal block width: 6.2 mm, lettering field size: 5.15 x 6.15 mm, Number of individual labels: 10

Marker for terminal blocks

Marker for terminal blocks - UCT-TM 6 - 0828736

<https://www.phoenixcontact.com/de/produkte/0828736>



Marker for terminal blocks, Sheet, white, unlabeled, can be labeled with: TOPMARK NEO, TOPMARK LASER, BLUEMARK ID COLOR, BLUEMARK ID, BLUEMARK CLED, THERMOMARK PRIME, THERMOMARK CARD 2.0, THERMOMARK CARD, mounting type: snapped, for terminal block width: 6.2 mm, lettering field size: 5.6 x 10.5 mm, Number of individual labels: 60

Electronic circuit breaker - PTCB E1 24DC/4A NO



2909906

<https://www.phoenixcontact.com/de/produkte/2909906>

Marker for terminal blocks

Marker for terminal blocks - UCT-TM 6 CUS - 0829602

<https://www.phoenixcontact.com/de/produkte/0829602>



Marker for terminal blocks, can be ordered: by sheet, white, labeled according to customer specifications, mounting type: snap into tall marker groove, for terminal block width: 6.2 mm, lettering field size: 5.6 x 10.5 mm, Number of individual labels: 60

Marker for terminal blocks

Marker for terminal blocks - US-TML (104X3,8) - 0830768

<https://www.phoenixcontact.com/de/produkte/0830768>



Marker for terminal blocks, Card, white, unlabeled, can be labeled with: BLUEMARK ID COLOR, BLUEMARK ID, THERMOMARK PRIME, THERMOMARK CARD 2.0, THERMOMARK CARD, mounting type: adhesive, lettering field size: 104 x 3.8 mm, Number of individual labels: 22

Electronic circuit breaker - PTCB E1 24DC/4A NO



2909906

<https://www.phoenixcontact.com/de/produkte/2909906>

Type 3 surge protection device

Type 3 surge protection device - TTC-6P-T3-24DC-PT-I - 1027586

<https://www.phoenixcontact.com/de/produkte/1027586>



Type 3 surge protection, consisting of protective plug and base element, with integrated status indicator for 24 V DC power supplies

Wire bridge

Wire bridge - DB 50- 90 BK - 2820916

<https://www.phoenixcontact.com/de/produkte/2820916>

Flexible wire loop bridge, 50-pos., conductor cross-section: 0.5 mm², loop length: 90 mm, ferrule length: 8 mm, color: black



Electronic circuit breaker - PTCB E1 24DC/4A NO



2909906

<https://www.phoenixcontact.com/de/produkte/2909906>

Wire bridge

Wire bridge - DB 50- 90 BU - 2821180

<https://www.phoenixcontact.com/de/produkte/2821180>

Flexible wire loop bridge, 50-pos., conductor cross-section: 0.5 mm², loop length: 90 mm, ferrule length: 8 mm, color: blue



Wire bridge

Wire bridge - DB 50- 90 GY - 2820929

<https://www.phoenixcontact.com/de/produkte/2820929>

Flexible wire loop bridge, 50-pos., conductor cross-section: 0.5 mm², loop length: 90 mm, ferrule length: 8 mm, color: gray



Electronic circuit breaker - PTCB E1 24DC/4A NO



2909906

<https://www.phoenixcontact.com/de/produkte/2909906>

Wire bridge

Wire bridge - DB 50- 90 RD - 2864639

<https://www.phoenixcontact.com/de/produkte/2864639>

Flexible wire loop bridge, 50-pos., conductor cross-section: 0.5 mm², loop length: 90 mm, ferrule length: 8 mm, color: red

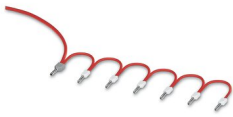

Phoenix Contact 2022 © - all rights reserved

<https://www.phoenixcontact.com>

PHOENIX CONTACT Deutschland GmbH

Flachsmarktstraße 8

D-32825 Blomberg

+49 52 35/3-1 20 00

info@phoenixcontact.de